

## AMT U - SERIES

### Tweeter

Our goal: A ,reduced to the maximum' model range of **AMT tweeters** which cover all possible applications in home- and studio-audio. The development engineers therefore had the task of keeping the design as simple, straightforward and versatile as possible without compromising the central **AMT element** -the diaphragm- which determines the tweeter's final sound quality. Rather, this should be further optimized based on the experience and knowledge gained from more than 15 years of our diaphragm development.

All of our **AMT diaphragms** are manufactured in-house by a unique manufacturing process of our own development. The mixture of our basic diaphragm material was optimized with focus on its acoustic properties, hereafter the manufacturing process was tailored to ensure the very best acoustic result possible with every single diaphragm material mix.

Every detail of our diaphragm's geometry is based on a deep understanding of the mechanical requirements and physical properties of an **AMT diaphragm**. Only with this knowledge is it possible to achieve the perfect ratio of a low diaphragm weight, the highest possible diaphragm flexibility, and the most effective inner damping at a maximum of diaphragm stability. Even the slightest shift within this well-balanced ratio would lead to audibly worse results.

This out-balanced ratio makes the **Mundorf AMT diaphragm** one of its kind. Due to its exceptionally high inner damping, it is characterized by extremely low distortion data. This applies particularly to the odd-numbered harmonic distortions K3 and K5.

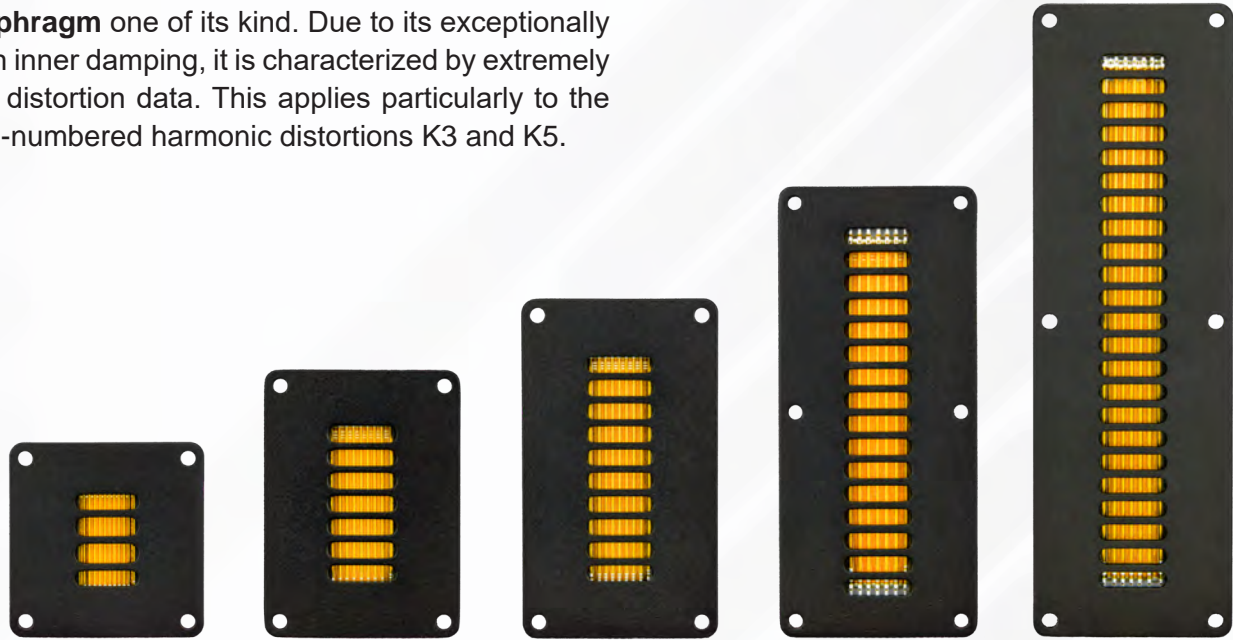

Embedded in a well-thought-out, optimized overall concept, this membrane technology can reproduce the highest SPL as well as the finest dynamic nuances with extreme low distortion. So, even at very high volume music performance never gets 'annoying'.

The relatively heavy weight of the diaphragm and its structural stiffness, together with extra strong magnet systems, lead to a remarkably powerful music reproduction down to its resonance frequency!

In addition to the extremely low K3 / K5 distortion data, this is another unique feature of the **Mundorf AMT diaphragms**.

The correct interaction of diaphragm and damping of its rear volume was also carefully ascertained. In addition to aesthetic aspects, a simple structure easy to produce serially with utmost precision, and a robust over-all finish were crucial for the final shape of the new **AMT U.Series**.

## AMT U40W1.1

Tweeter

Samples available: Immediately  
Start of sale: Immediately

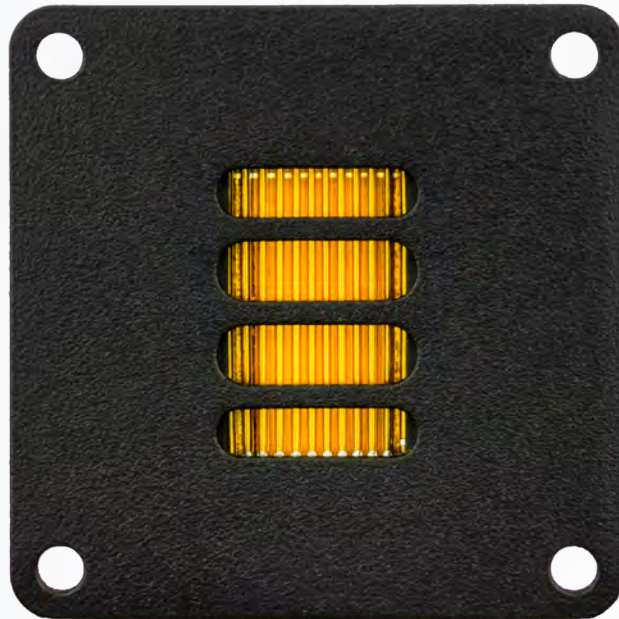

The **AMT U40W1.1** is the smallest model in the **U.Series**. It is suitable for 2-way table top speakers as well as for 3-way floor standing speakers. Thanks to its compact design, the **AMT U40W1.1** can also be effortlessly integrated into Car- HiFi systems. Small as it is, it provides all the quality features of the **AMT U.Series** with **Mundorf diaphragm**: Exceptionally low K3 / K5 distortion data, a truly powerful music performance within the entire application range and, at the same time, the fine micro-dynamics and richness of music details that distinguish all **Mundorf AMT's**.



## Specifications

Nominal Impedance	4 Ω
DC Resistance ( $R_{dc}$ ) ( $Z_{min}$ )	3.7 Ω
Sensitivity (2,83 V / 1m) <sup>1</sup>	92 dB
Resonance Frequency (FS)	3900 Hz
Frequency Response (-6dB)	3.2 kHz - 39 kHz
Frequency Response (-10dB) <sup>1</sup>	2.7 kHz - 43 kHz
Crossover from (filter 12dB/6dB/Oct.)	3.5 kHz / 5.0 kHz
Nominal Frequency Range <sup>3</sup>	3.5 kHz - 39 kHz
Power Handling, long term <sup>1,2</sup>	10 W
Power Handling, short term <sup>1,2</sup>	80 W
Max. Input Voltage, long term <sup>1,2</sup>	6.3 V <sub>rms</sub>
Max. Input Voltage, short term <sup>1,2</sup>	17.9 V <sub>rms</sub>
Effective Piston Area	13.5 cm <sup>2</sup>
Total Weight	0.174 kg
Face Plate	optional

- 1) according to IEC 60268-5  
 2) via High Pass Filter, Butterworth 3500 Hz 12 dB/Okt.  
 3) according to power measurement

## Interactive 3D Model

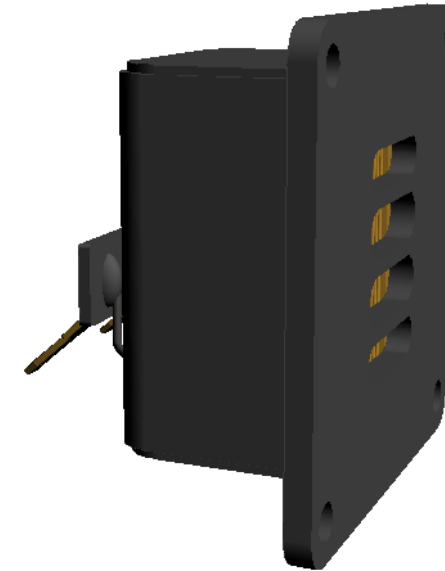

## Measurements

SPL Horizontal 0° - 15° - 30° - 45°

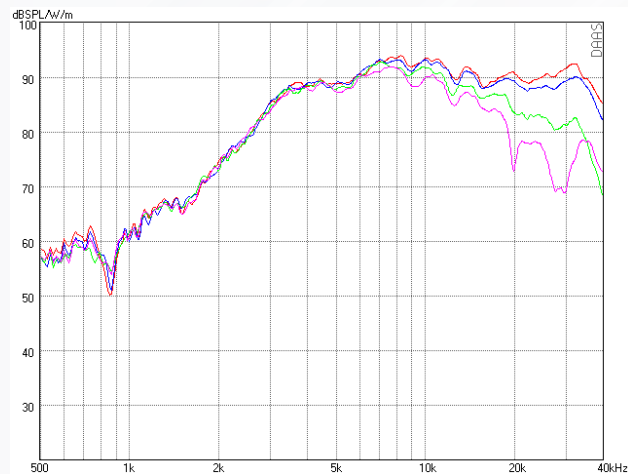

SPL Vertical 0° - 10° - 20° - 30°

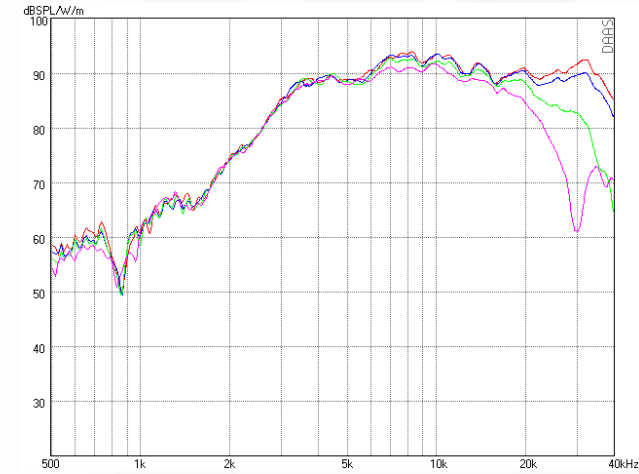

Measurements

SPL - Impedance

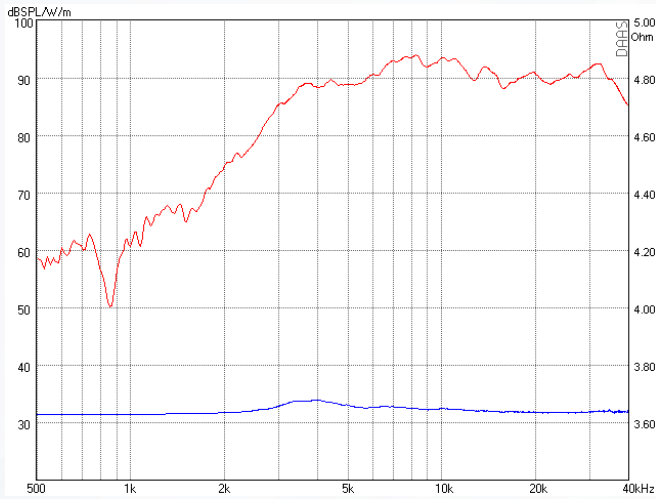

Harmonic Distortion 2.83 V

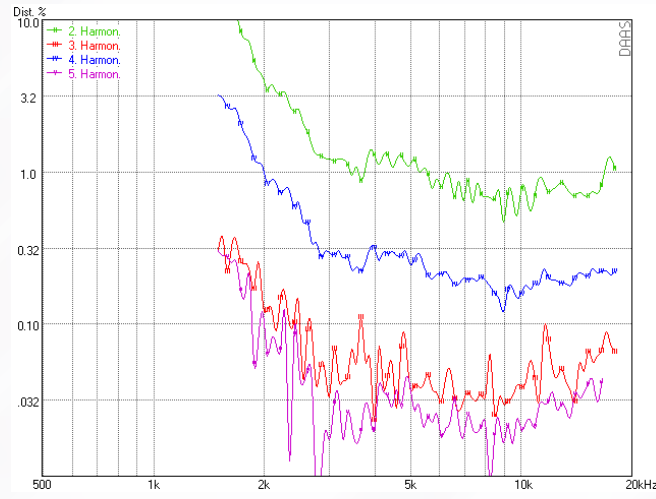

Waterfall

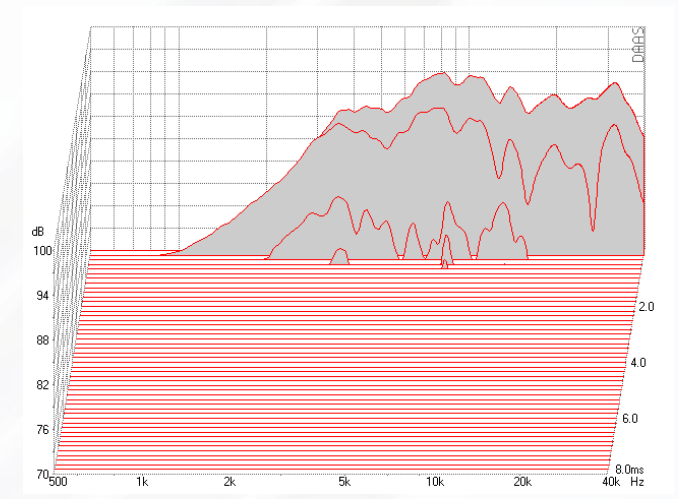

SPL - Phase

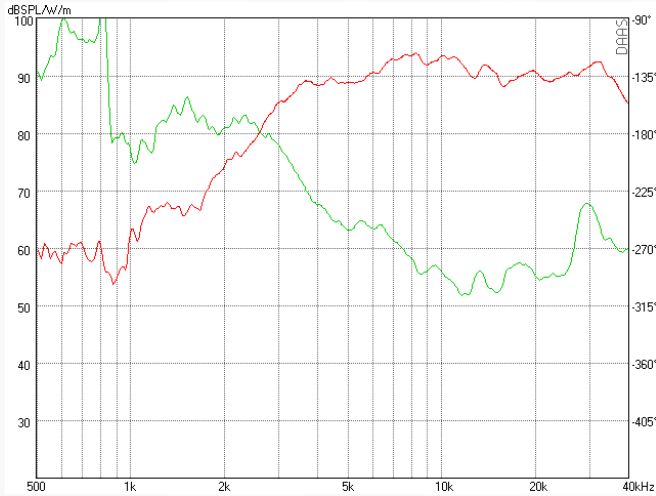

Impulse Response

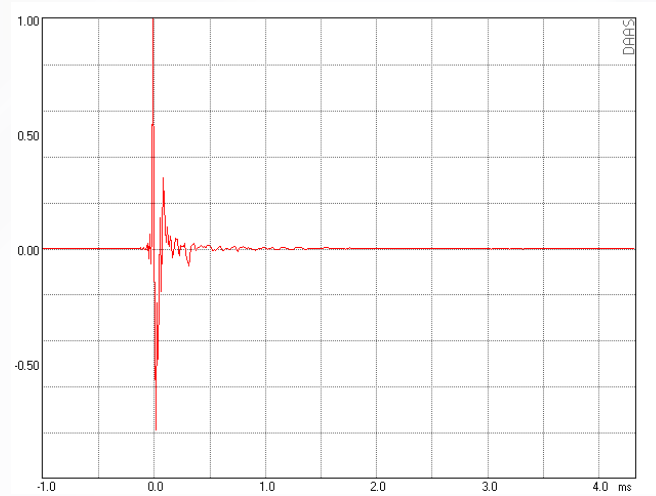

Step Response

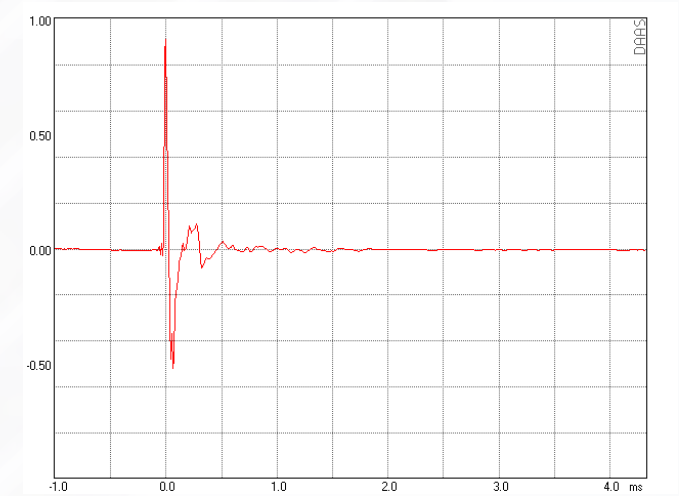

Dimensions

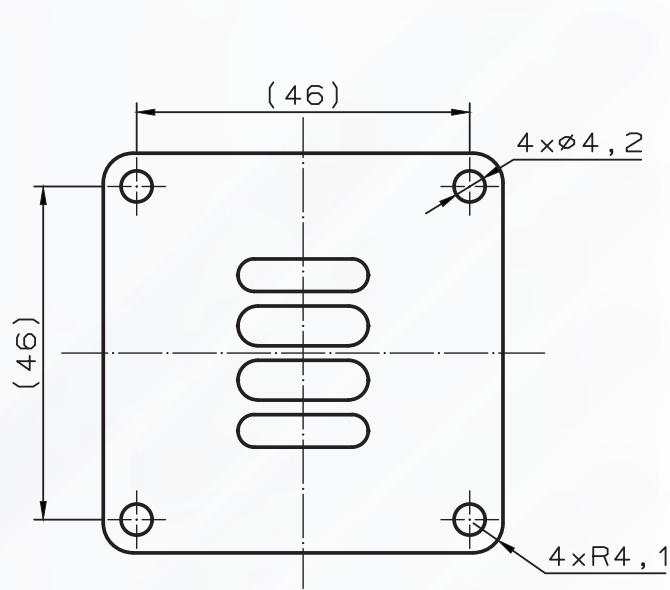

Front view

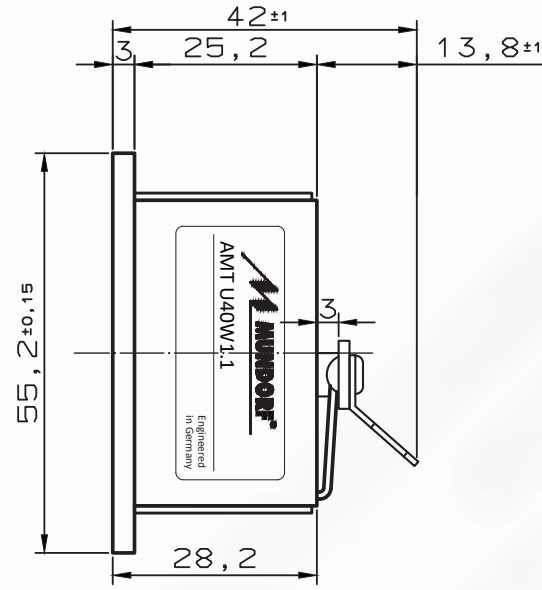

Sideview

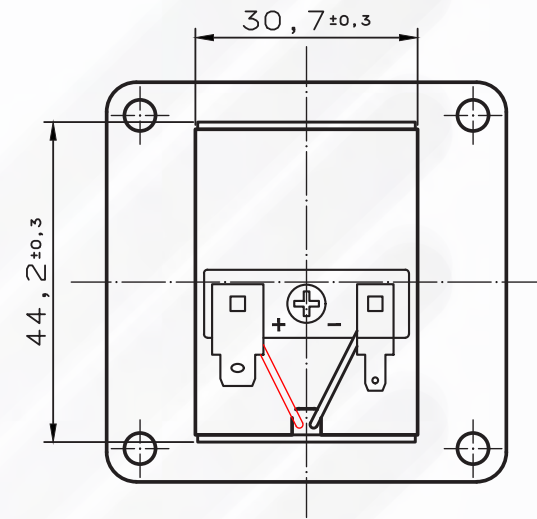

Rear view

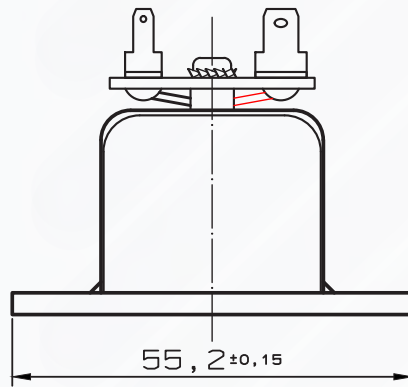

Top view

	Dimensions	Tolerance
Length	55 mm	+ 0,5 mm
Width	55 mm	+ 0,5 mm
Depth including terminal	42 mm	+/- 1 mm

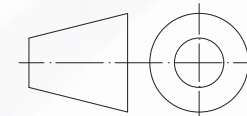

All measurements are in mm.

## AMT U60W1.1

Tweeter

Samples available: Immediately  
Start of sale: Immediately

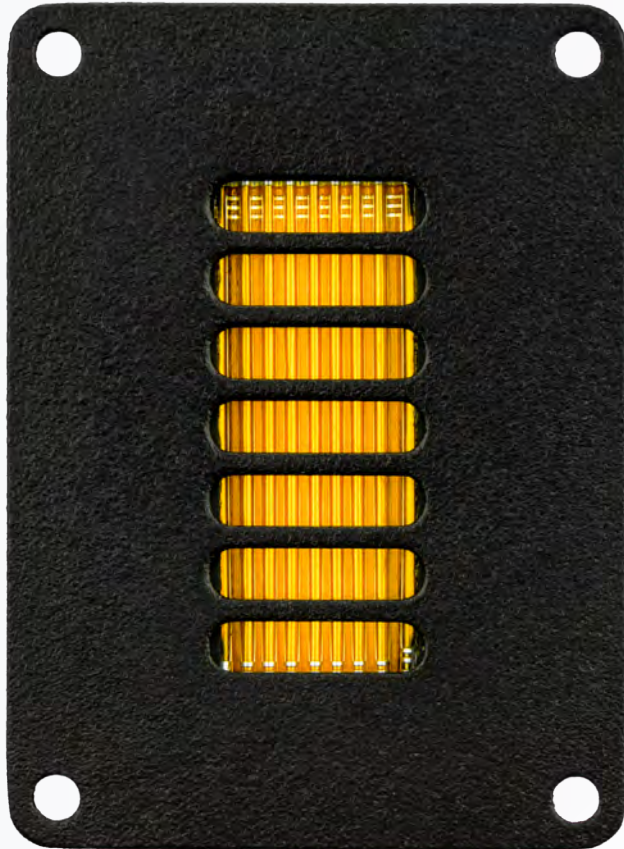

**AMT U60W1.1** and **AMT U80W1.1** could be described as the small and the large all-rounder of this product range. Both can be used in small or medium 2-way and 3-way systems. **AMT U60W1.1** offers a slightly larger vertical radiation angle. So it's ideally suited for situations with a short listening distance. Both convince with the decisive quality features of the **AMT U.Series** with **Mundorf diaphragm**: Exceptionally low K3 / K5 distortion data, a truly powerful music performance within the entire application range and, at the same time, the fine micro-dynamics and richness of music details that distinguish all **Mundorf AMT's**.



## Specifications

Nominal Impedance	4 $\Omega$
DC Resistance ( $R_{dc}$ ) ( $Z_{min}$ )	4.0 $\Omega$
Sensitivity (2,83 V / 1m) <sup>1</sup>	93 dB
Resonance Frequency (FS)	2350 Hz
Frequency Response (-6dB)	2.1 kHz - 34 kHz
Frequency Response (-10dB) <sup>1</sup>	1.8 kHz - 36 kHz
Crossover from (filter 12dB/6dB/Oct.)	2.2 kHz / 3.3 kHz
Nominal Frequency Range <sup>3</sup>	2.5 kHz - 34 kHz
Power Handling, long term <sup>1,2</sup>	10 W <sub>rms</sub>
Power Handling, short term <sup>1,2</sup>	70 W <sub>rms</sub>
Max. Input Voltage, long term <sup>1,2</sup>	6.3 V <sub>rms</sub>
Max. Input Voltage, short term <sup>1,2</sup>	16.4 V <sub>rms</sub>
Effective Piston Area	20.1 cm <sup>2</sup>
Total Weight	0.254 kg
Face Plate	optional

- 1) according to IEC 60268-5  
 2) via High Pass Filter, Butterworth 2500 Hz 12 dB/Okt.  
 3) according to power measurement

## Interactive 3D Model

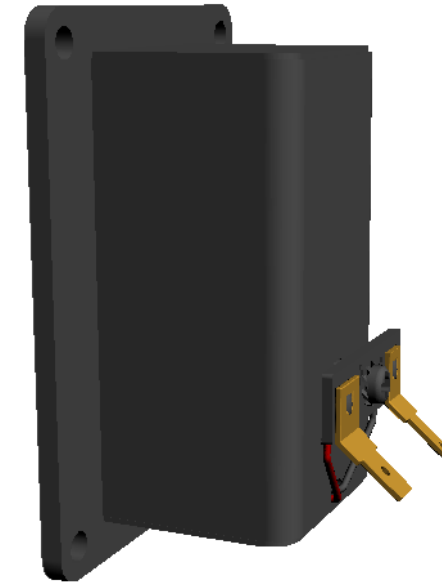

## Measurements

SPL Horizontal 0° - 15° - 30° - 45°

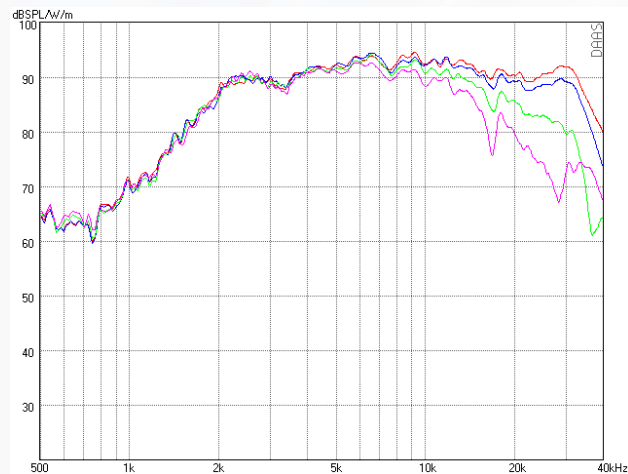

SPL Vertical 0° - 10° - 20° - 30°

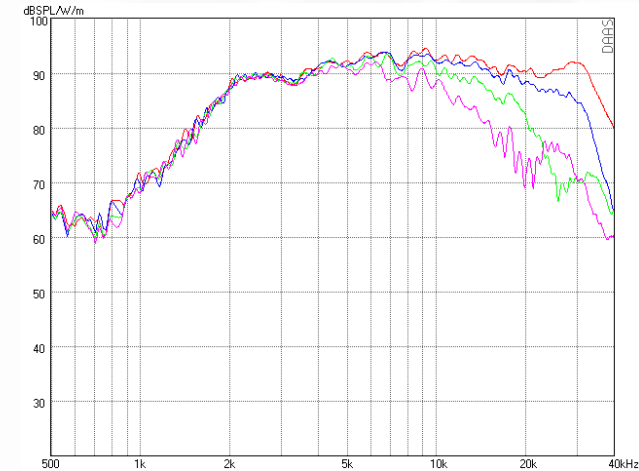

Measurements

SPL - Impedance

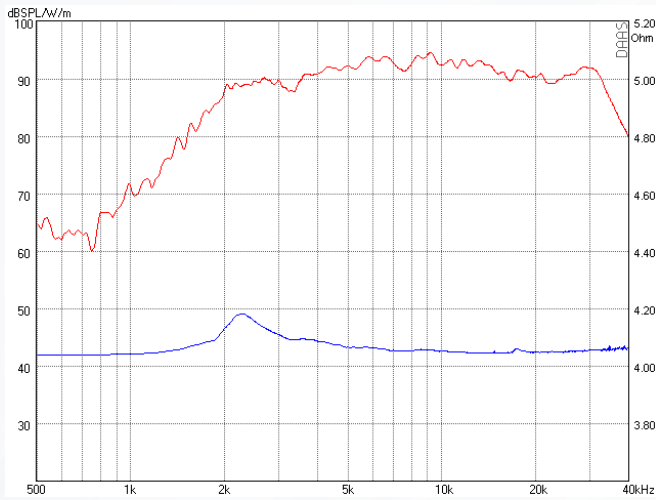

Harmonic Distortion 2.83 V

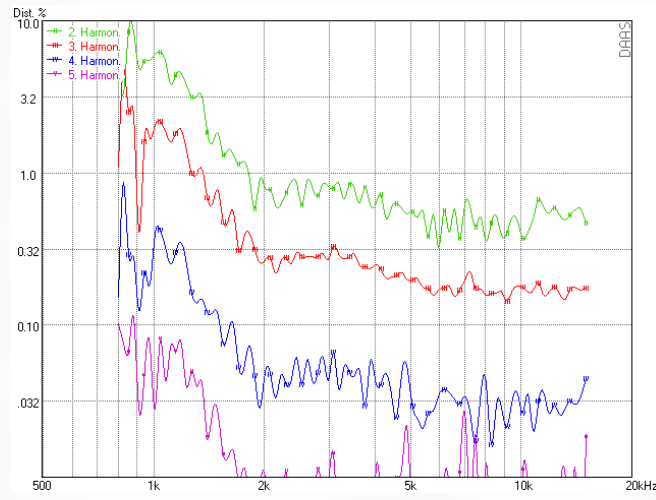

Waterfall

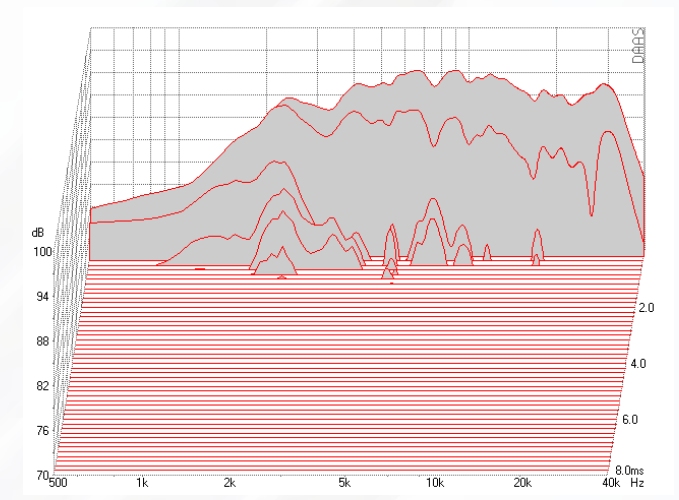

SPL - Phase

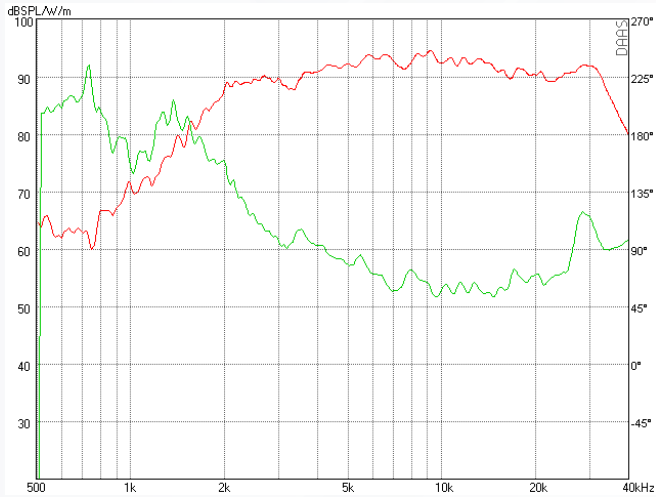

Impulse Response

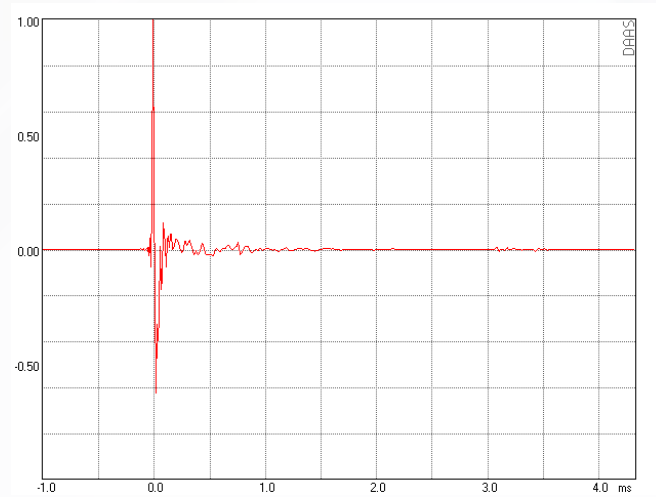

Step Response

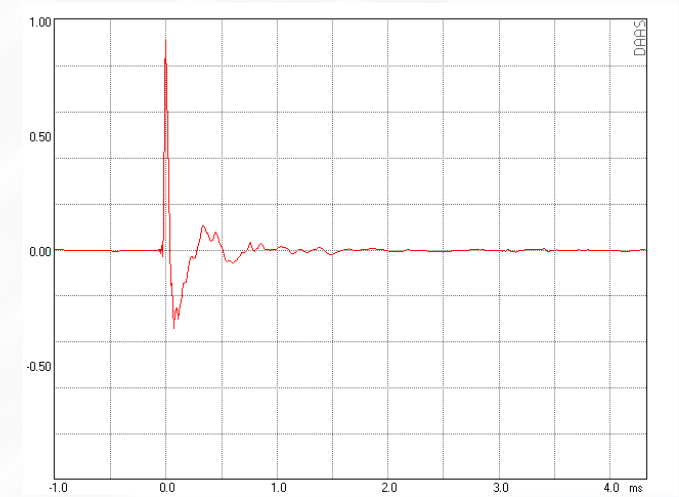



Dimensions

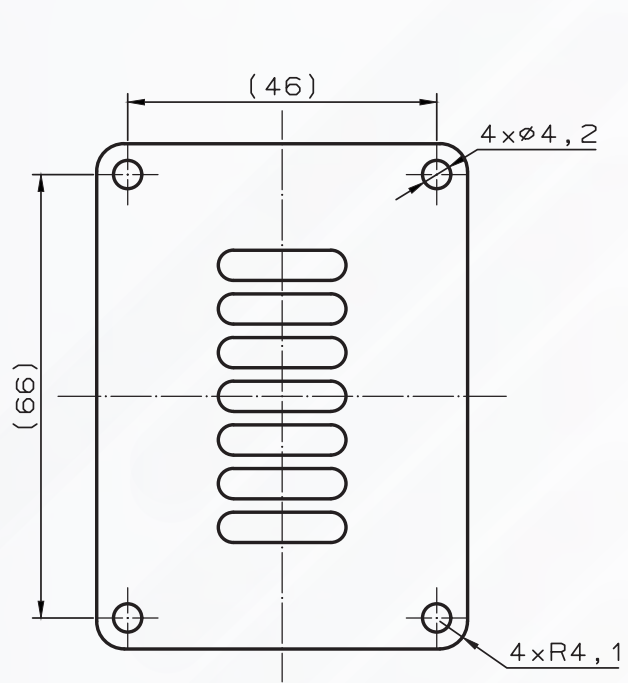

Front view

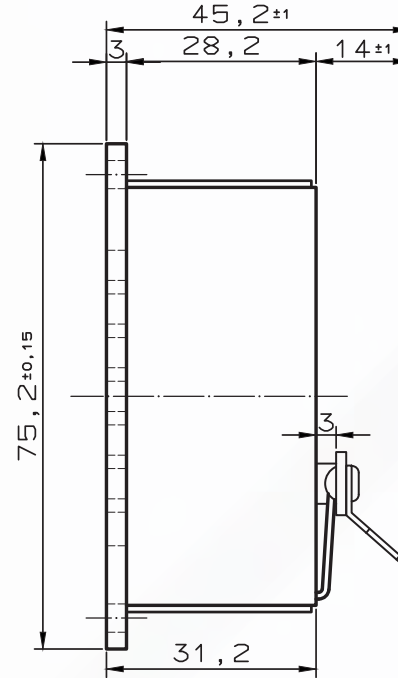

Sideview

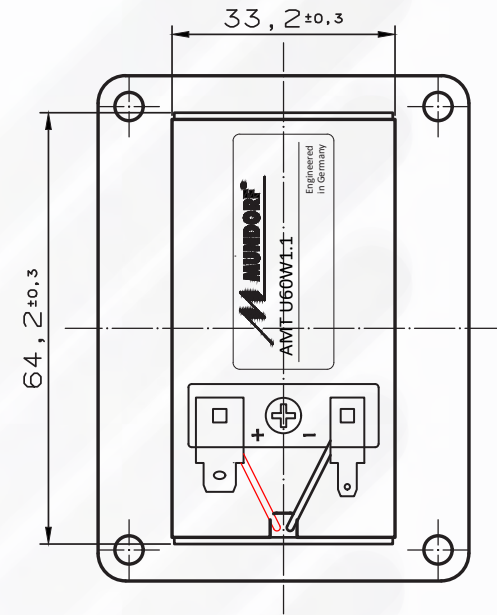

Rear view

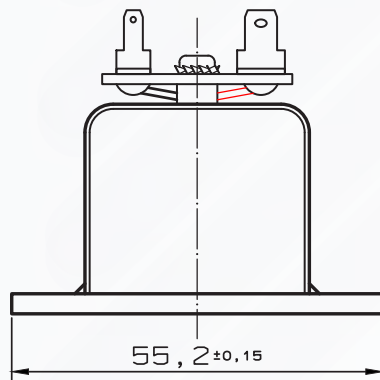

Top view

	Dimensions	Tolerance
Length	75 mm	+ 0,5 mm
Width	55 mm	+ 0,5 mm
Depth including terminal	45 mm	+/- 1 mm

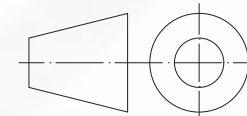

All measurements are in mm.

## AMT U80W1.1

Tweeter

Samples available: Immediately  
Start of sale: Immediately

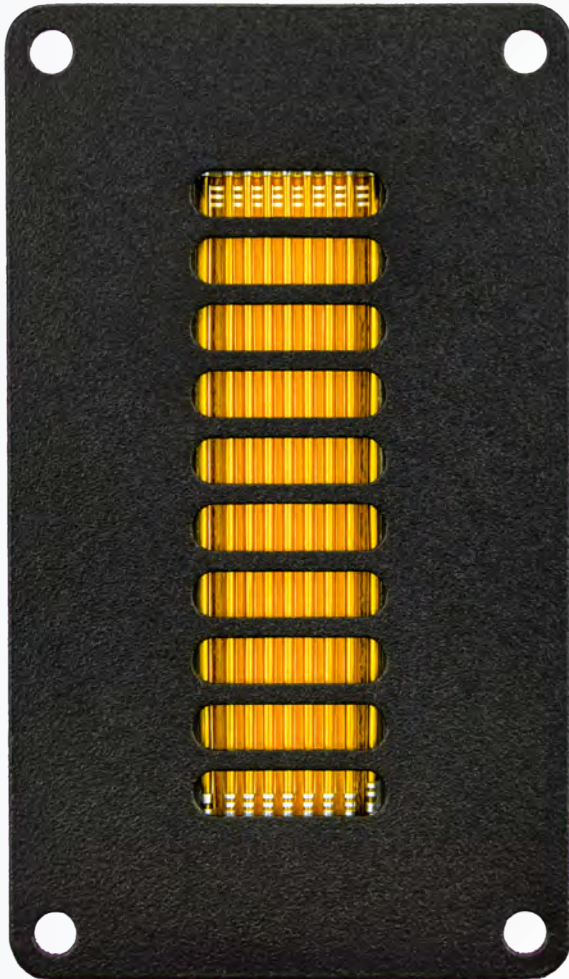

**AMT U60W1.1** and **AMT U80W1.1** could be described as the small and the large all-rounder of this product range. Both can be used in small or medium 2-way and 3-way systems. **AMT U80W1.1** offers additional dynamic range. Both convince with the decisive quality features of the **AMT U.Series** with **Mundorf diaphragm**: Exceptionally low K3 / K5 distortion data, a truly powerful music performance within the entire application range and, at the same time, the fine micro-dynamics and richness of music details that distinguish all **Mundorf AMT's**.



## Specifications

Nominal Impedance	4 Ω
DC Resistance ( $R_{dc}$ ) ( $Z_{min}$ )	4.4 Ω
Sensitivity (2,83 V / 1m) <sup>1</sup>	94 dB
Resonance Frequency (FS)	2150 Hz
Frequency Response (-6dB)	1.8 kHz - 31 kHz
Frequency Response (-10dB) <sup>1</sup>	1.4 kHz - 34 kHz
Crossover from (filter 12dB/6dB/Oct.)	2.0 kHz / 3.0 kHz
Nominal Frequency Range <sup>3</sup>	2.2 kHz - 31 kHz
Power Handling, long term <sup>1,2</sup>	15 W
Power Handling, short term <sup>1,2</sup>	90 W
Max. Input Voltage, long term <sup>1,2</sup>	7.7 V <sub>rms</sub>
Max. Input Voltage, short term <sup>1,2</sup>	19 V <sub>rms</sub>
Effective Piston Area	31.4 cm <sup>2</sup>
Total Weight	0.360 kg
Face Plate	optional

1) according to IEC 60268-5  
 2) via High Pass Filter, Butterworth 2200 Hz 12 dB/Okt.  
 3) according to power measurement

## Interactive 3D Model

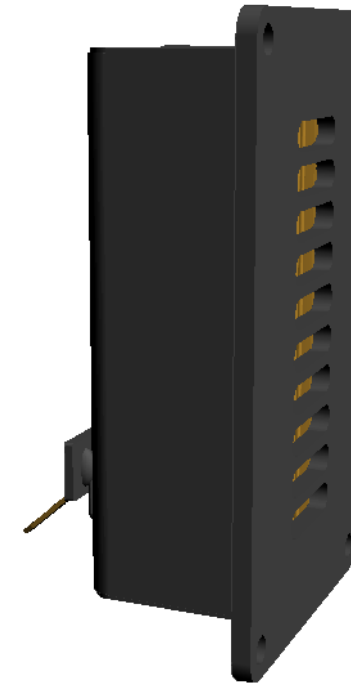

## Measurements

SPL Horizontal 0° - 15° - 30° - 45°

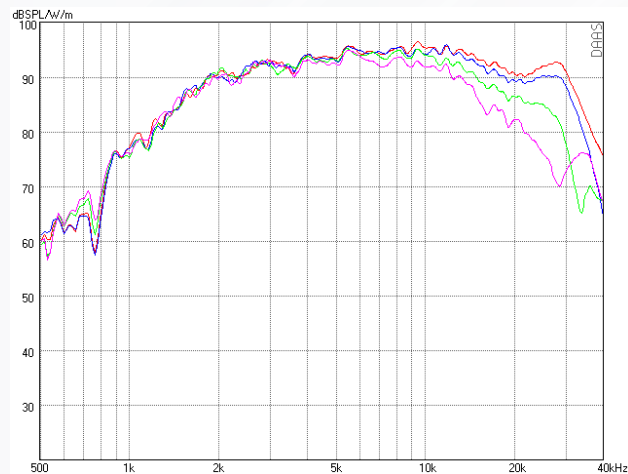

SPL Vertical 0° - 10° - 20° - 30°

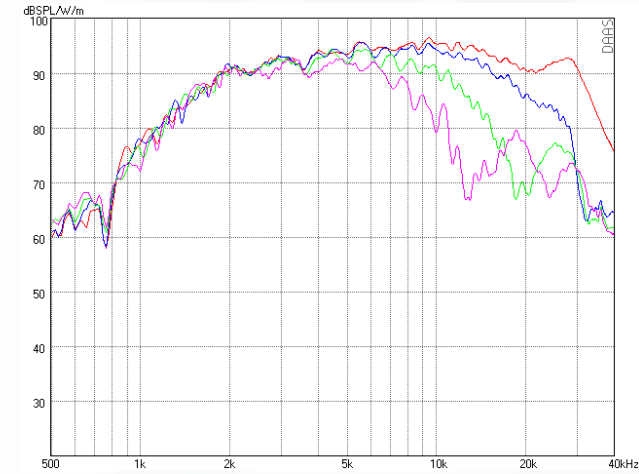

Measurements

SPL - Impedance

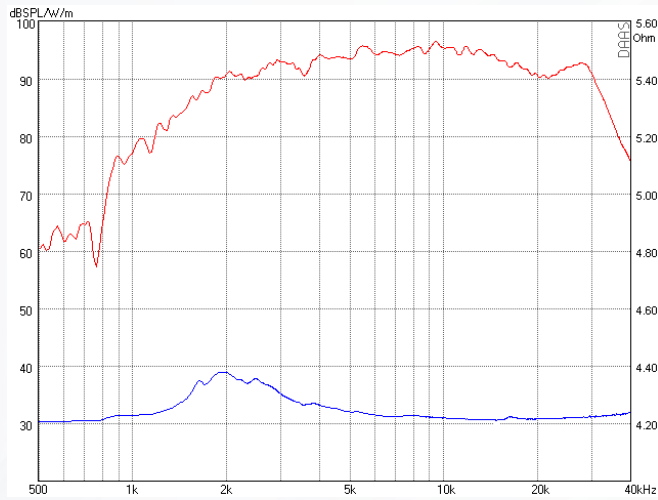

Harmonic Distortion 2.83 V

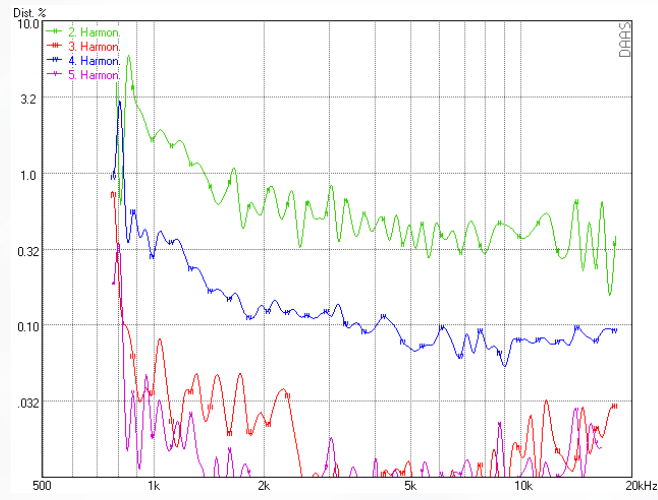

Waterfall

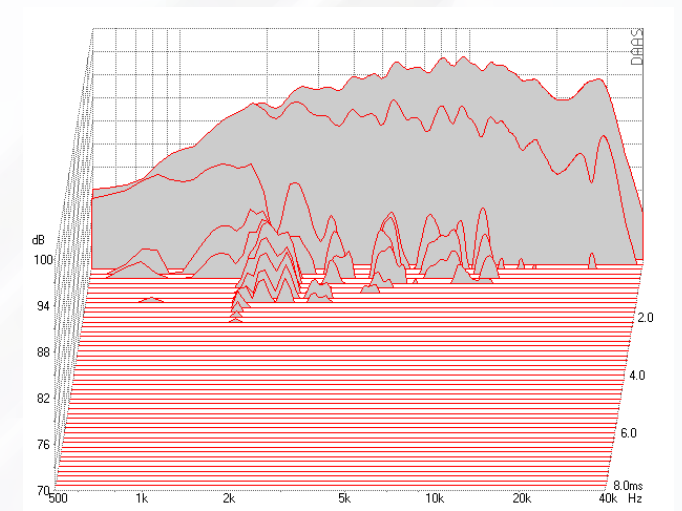

SPL - Phase

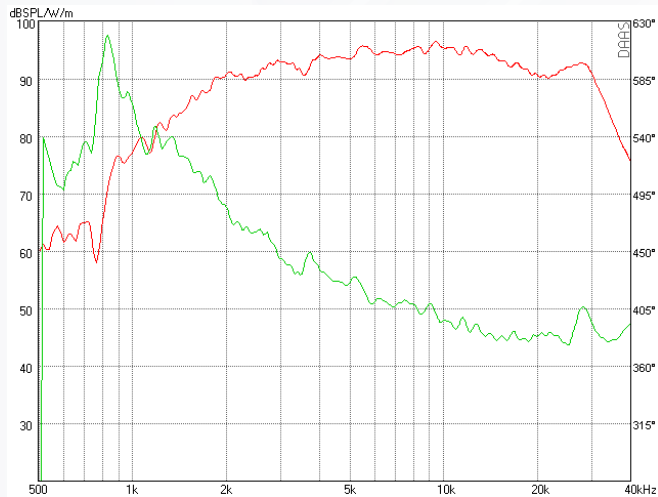

Impulse Response

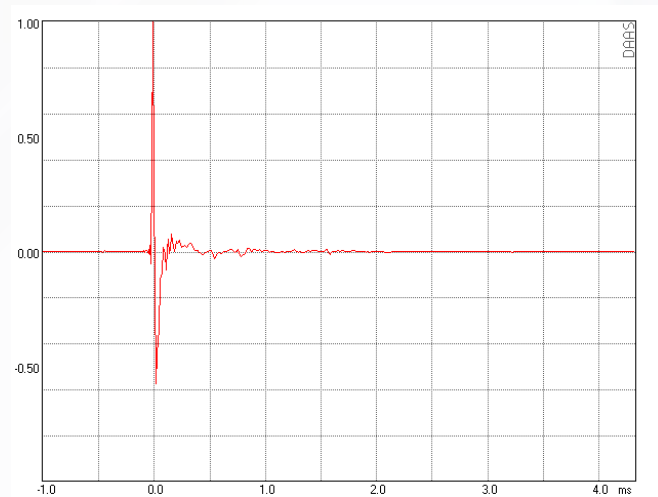

Step Response

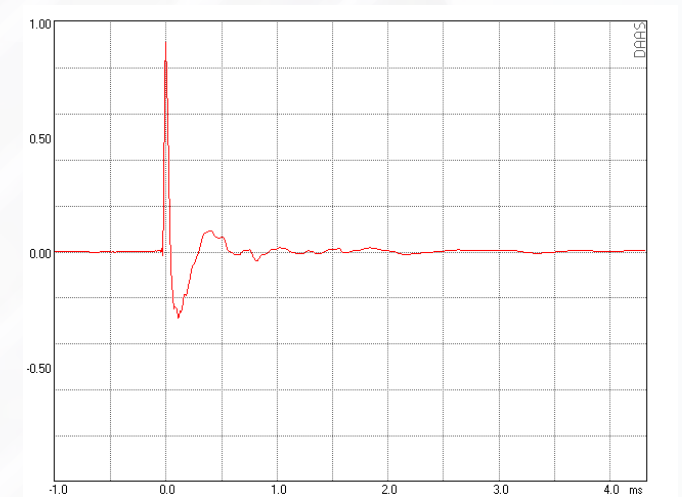

Dimensions

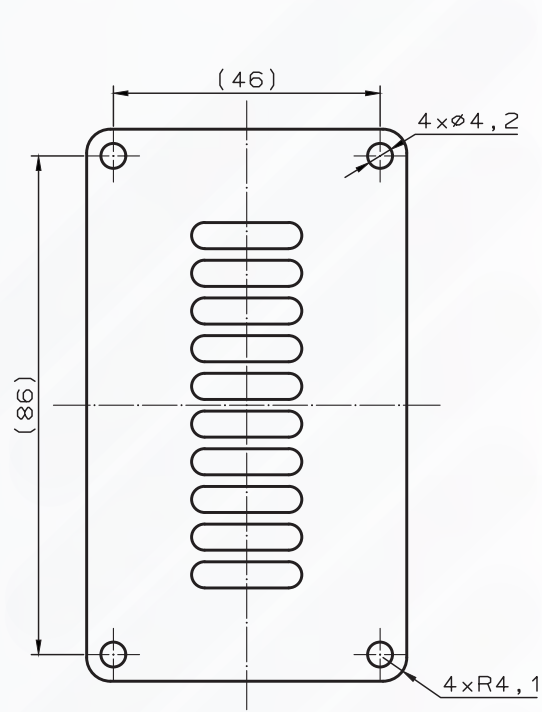

Front view

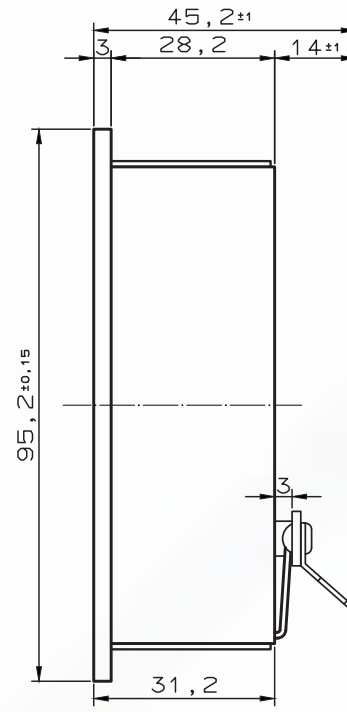

Sideview

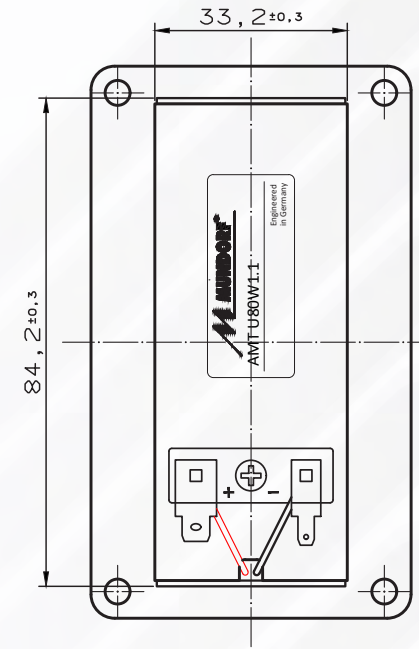

Rear view

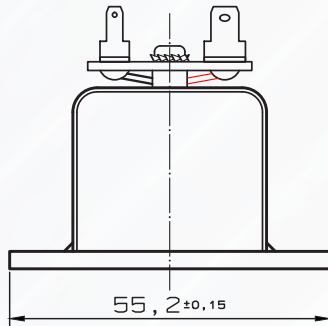

Top view

	Dimensions	Tolerance
Length	95 mm	+ 0,5 mm
Width	55 mm	+ 0,5 mm
Depth including terminal	45 mm	+/- 1 mm

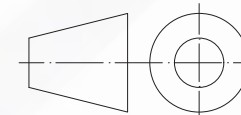

All measurements are in mm.

## AMT U110W1.1

Tweeter

Samples available: Immediately

Start of sale: Immediately

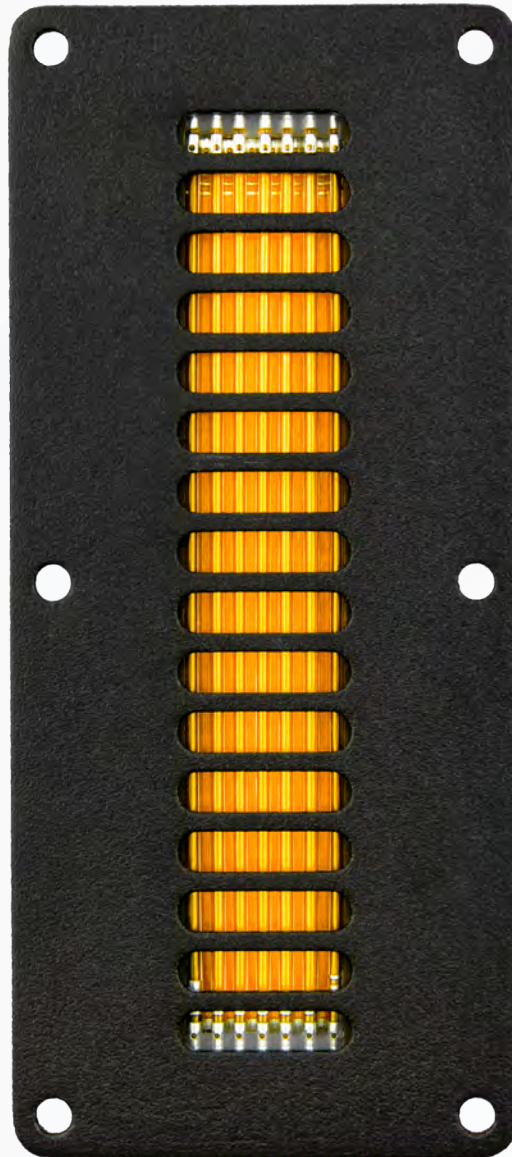

**AMT U110W1.1** offers huge SPL reserves for large floor standing speakers with a low crossover frequency or for quite demanding home-theater speakers. It is predestined for applications where low ceiling or floor reflections might cause difficulties. Its SPL reserves, together with the decisive quality features of our **AMT U.Series** with **Mundorf diaphragm**, such as exceptionally low K3 / K5 distortion data, a truly powerful music performance within the entire application range and, at the same time, the fine micro-dynamics and richness of music details that distinguish all **Mundorf AMTs**, make **AMT U110W1.1** always the first choice when a little more of everything is in demand.



## Specifications

Nominal Impedance	6 $\Omega$
DC Resistance ( $R_{dc}$ )	5.5 $\Omega$
Sensitivity (2,83 V / 1m) <sup>1</sup>	93 dB
Resonance Frequency (FS)	1750 Hz
Frequency Response (-6dB)	1.7 kHz - 27 kHz
Frequency Response (-10dB) <sup>1</sup>	1.4 kHz - 28 kHz
Crossover from (filter 12dB/6dB/Oct.)	1.8 kHz / 2.7 kHz
Nominal Frequency Range <sup>3</sup>	2.0 kHz - 27 kHz
Power Handling, long term <sup>1,2</sup>	20 W <sub>rms</sub>
Power Handling, short term <sup>1,2</sup>	110 W <sub>rms</sub>
Max. Input Voltage, long term <sup>1,2</sup>	11 V <sub>rms</sub>
Max. Input Voltage, short term <sup>1,2</sup>	25.7 V <sub>rms</sub>
Effective Piston Area	43.6 cm <sup>2</sup>
Total Weight	0.455 kg
Face Plate	optional

1) according to IEC 60268-5  
 2) via High Pass Filter, Butterworth 2000 Hz 12 dB/Okt.  
 3) according to power measurement

## Interactive 3D Model



## Measurements

SPL Horizontal 0° - 15° - 30° - 45°

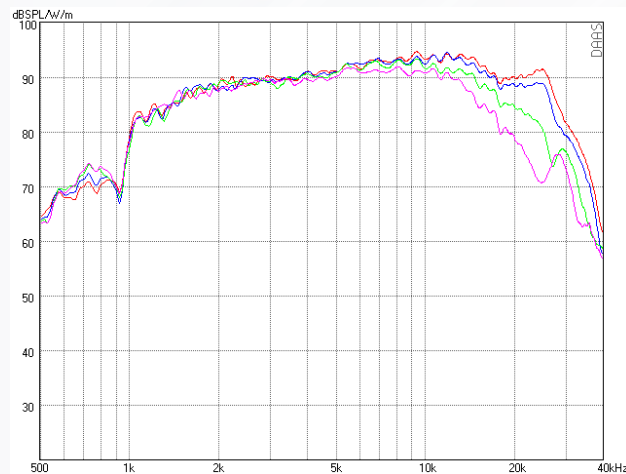

SPL Vertical 0° - 10° - 20° - 30°

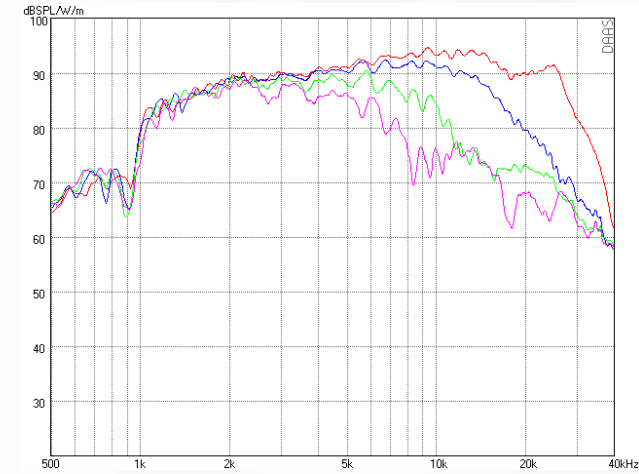

Measurements

SPL - Impedance

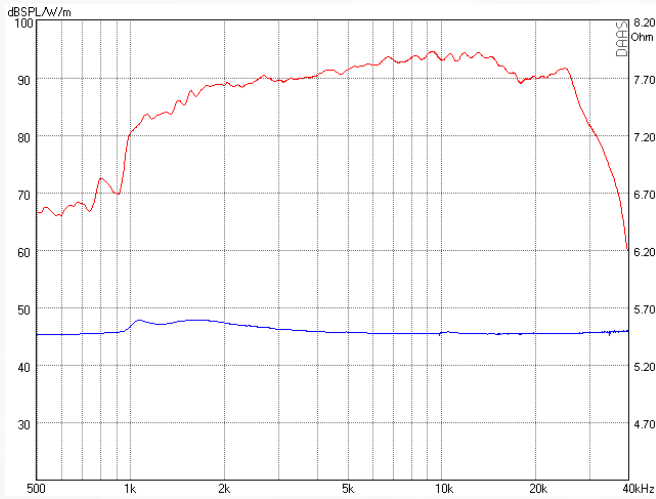

Harmonic Distortion 2.83 V

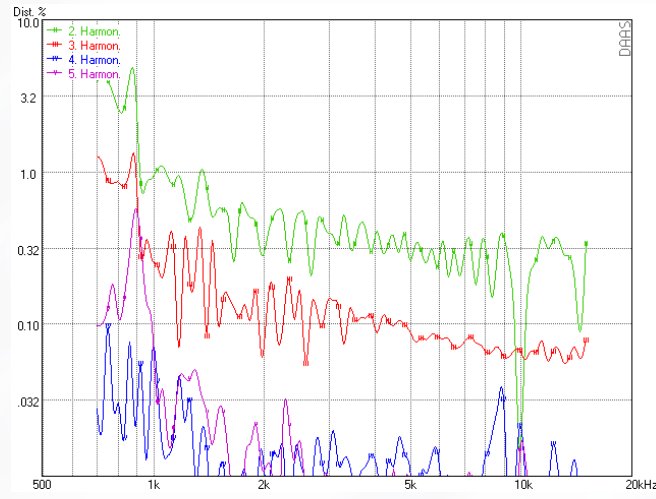

Waterfall

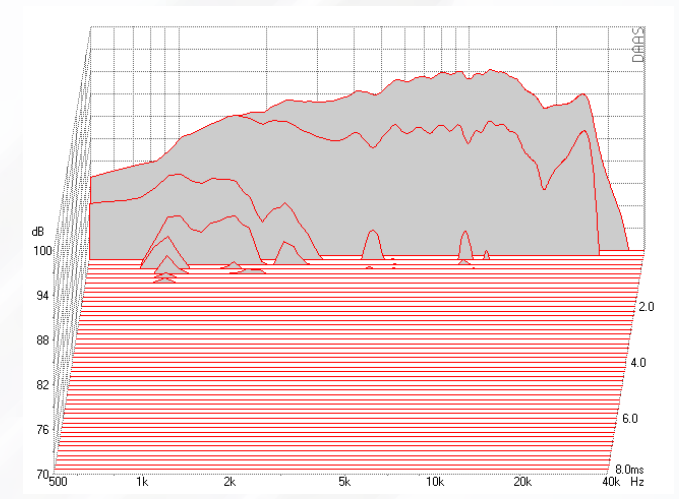

SPL - Phase

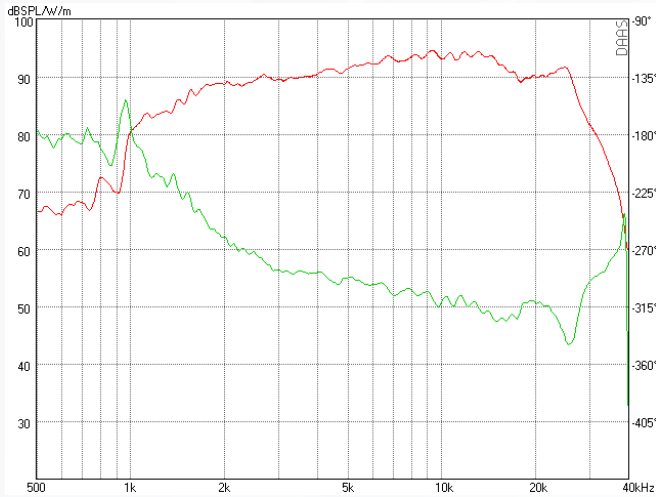

Impulse Response

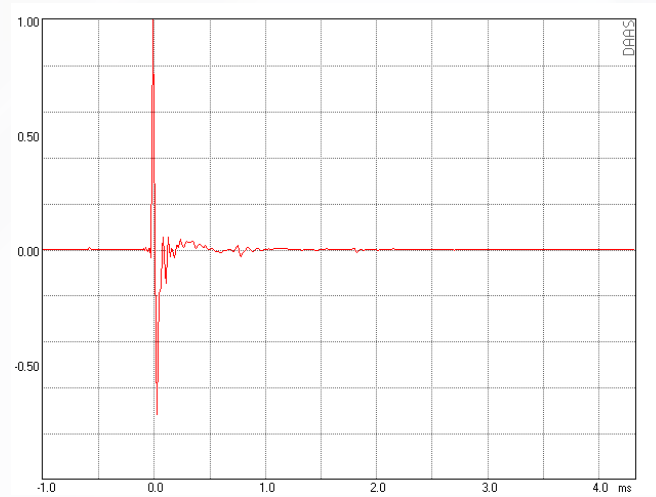

Step Response

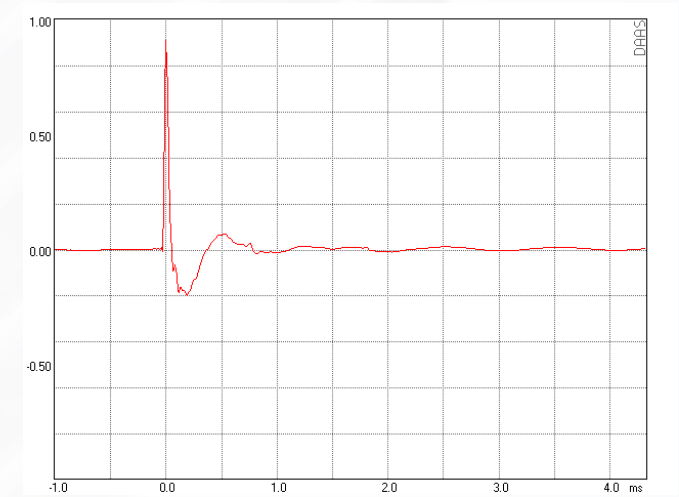



Dimensions

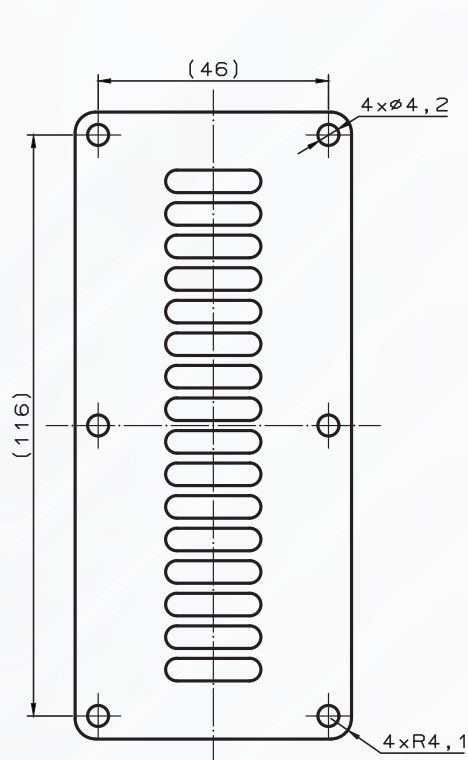

Front view

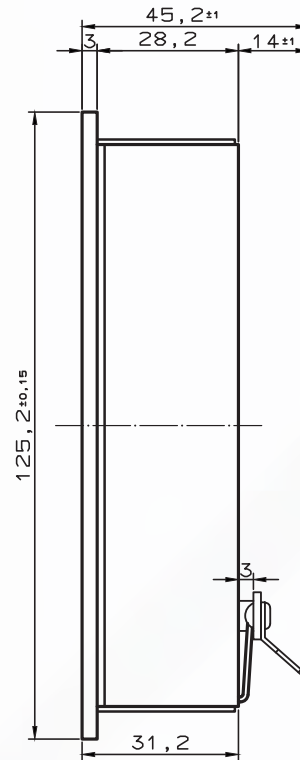

Sideview

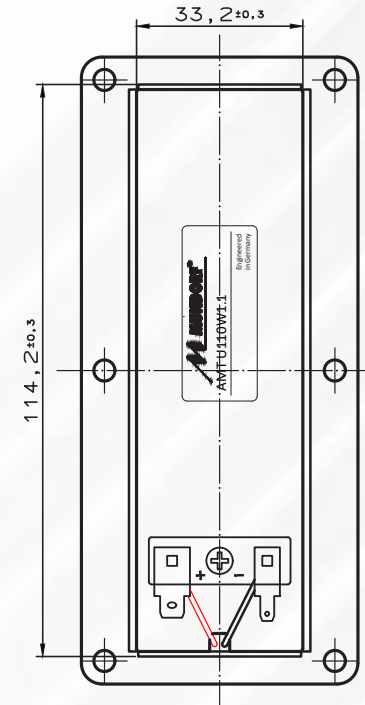

Rear view

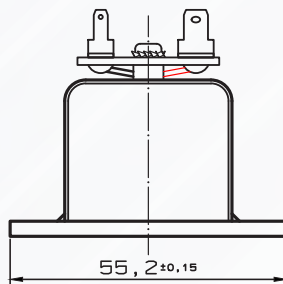

Top view

	Dimensions	Tolerance
Length	125 mm	+ 0,5 mm
Width	55 mm	+ 0,5 mm
Depth including terminal	45 mm	+/- 1 mm

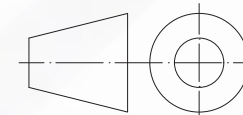

All measurements are in mm.

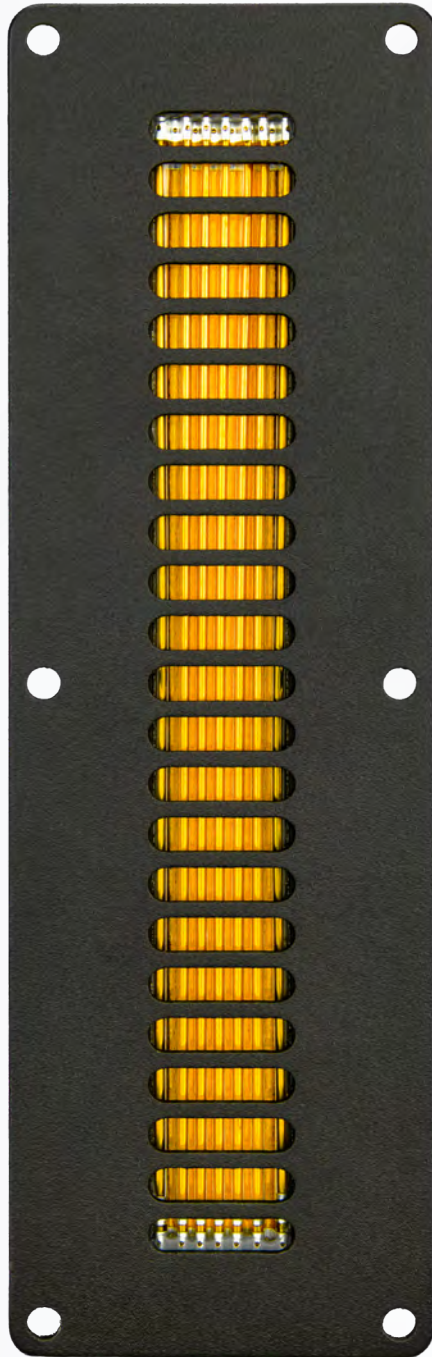

## AMT U160W1.1

### Tweeter

Samples available: Immediately  
Start of sale: Immediately

**AMT U160W1.1** combines its impressive SPL reserves with the decisive quality features of the **AMT U.Series** with **Mundorf diaphragm**: Exceptionally low K3 / K5 distortion data, a truly powerful music performance within the entire application range and, at the same time, the fine micro-dynamics and richness of music details that distinguish all **Mundorf AMT's**. The first choice when life-like music performance has to be achieved at farther distant listening areas. Be it with big floor standers in large rooms or surround speakers in huge luxury hi-end home cinemas. Due to its front panel geometry, it is ideally suited for vertical grouping of several tweeters in one line (stacking). In fact, with its remarkable performance **AMT U160W1.1** truly borders the domestic areas of PA applications.



## Specifications

Nominal Impedance	4 Ω
DC Resistance ( $R_{dc}$ ) ( $Z_{min}$ )	4.6 Ω
Sensitivity (2,83 V / 1m) <sup>1</sup>	93 dB
Resonance Frequency (FS)	1750 Hz
Frequency Response (-6dB)	1.2 kHz - 28 kHz
Frequency Response (-10dB) <sup>1</sup>	1.0 kHz - 30 kHz
Crossover from (filter 12dB / 6dB/ Oct.)	1.5 kHz / 2.3 kHz
Nominal Frequency Range <sup>3</sup>	1.6 kHz - 28 kHz
Power Handling, long term <sup>1,2</sup>	15 W <sub>rms</sub>
Power Handling, short term <sup>1,2</sup>	140 W <sub>rms</sub>
Max. Input Voltage, long term <sup>1,2</sup>	7.7 V <sub>rms</sub>
Max. Input Voltage, short term <sup>1,2</sup>	23.7 V <sub>rms</sub>
Effective Piston Area	68.1 cm <sup>2</sup>
Total Weight	0.630 kg
Face Plate	optional

- 1) according to IEC 60268-5  
 2) via High Pass Filter, Butterworth 2500 Hz 12 dB/Okt.  
 3) according to power measurement

## Interactive 3D Model



## Measurements

SPL Horizontal 0° - 15° - 30° - 45°

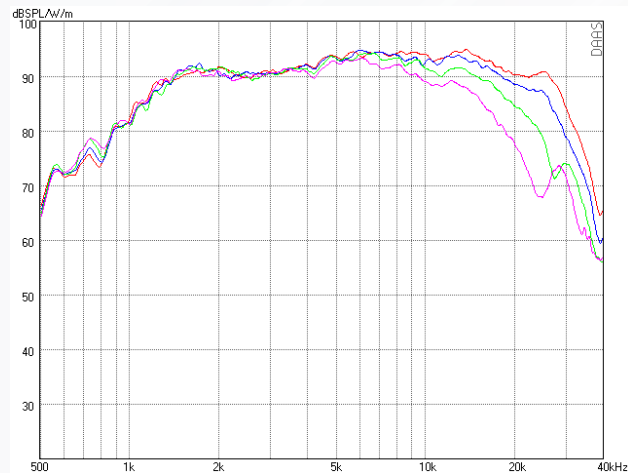

SPL Vertical 0° - 10° - 20° - 30°

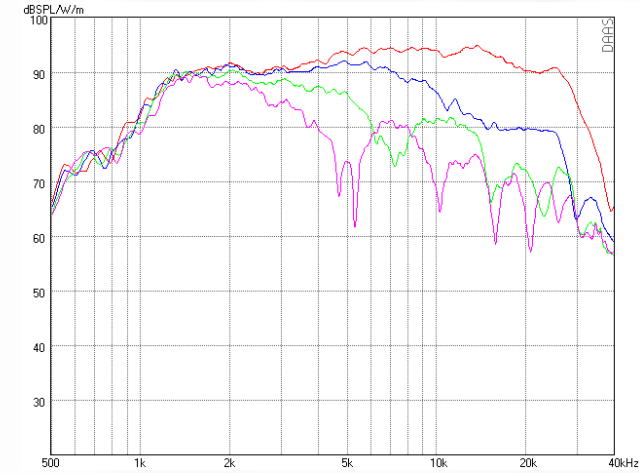

Measurements

SPL - Impedance

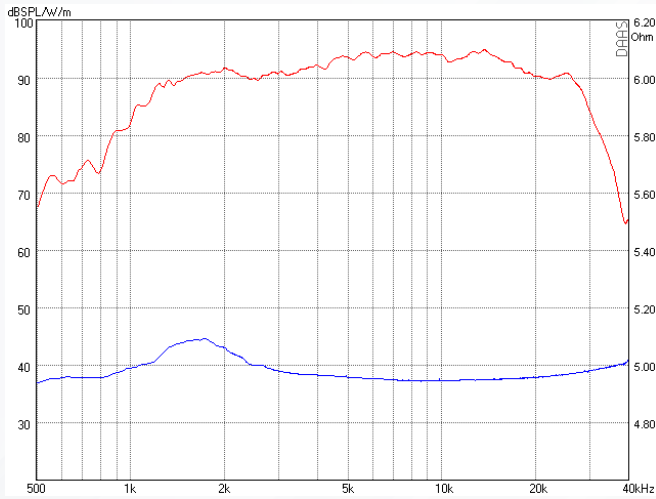

Harmonic Distortion 2.83 V

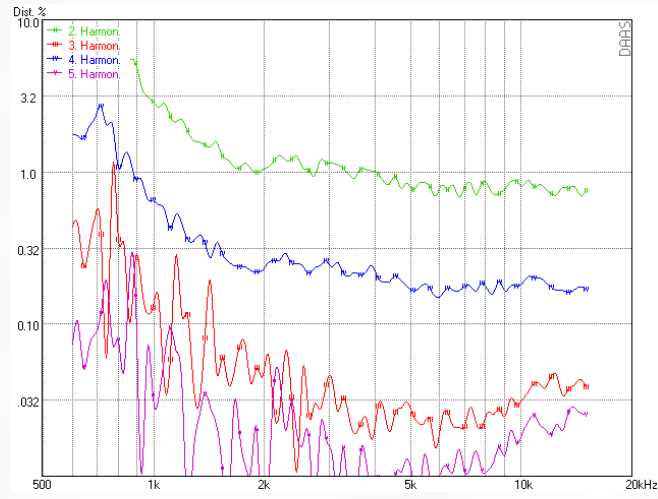

Waterfall

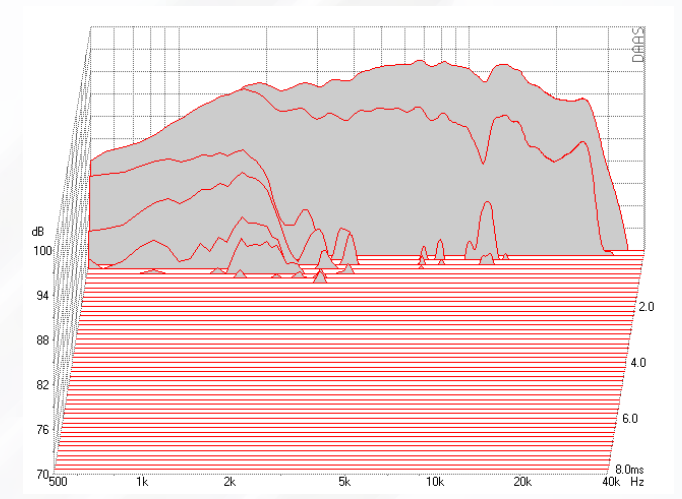

SPL - Phase

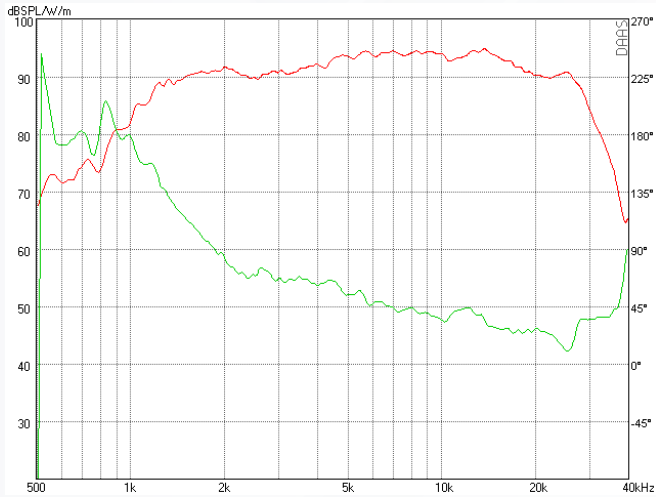

Impulse Response

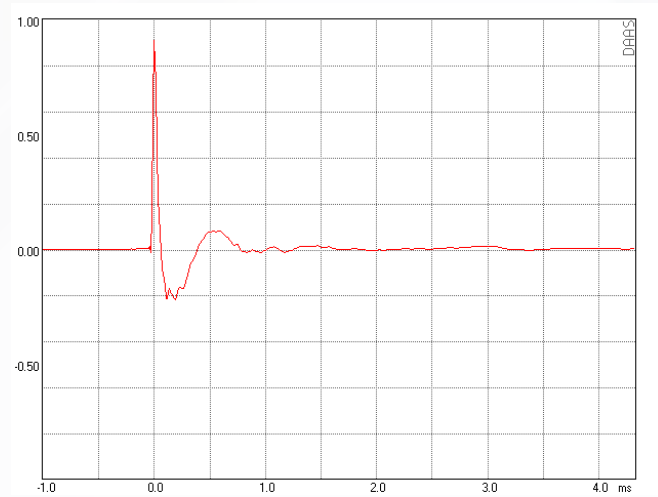

Step Response

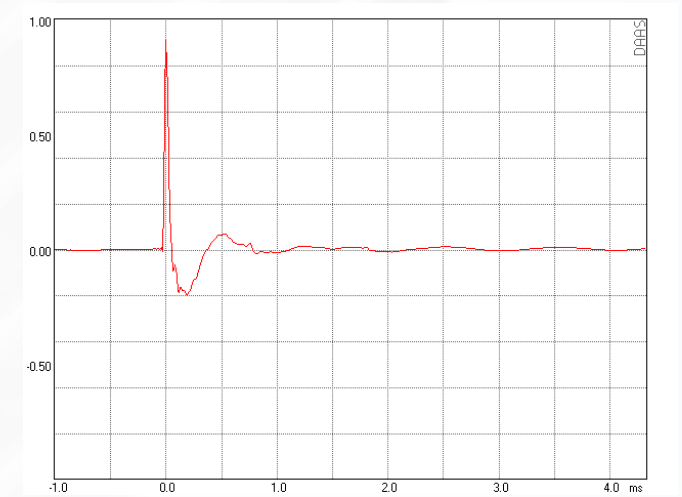

Dimensions

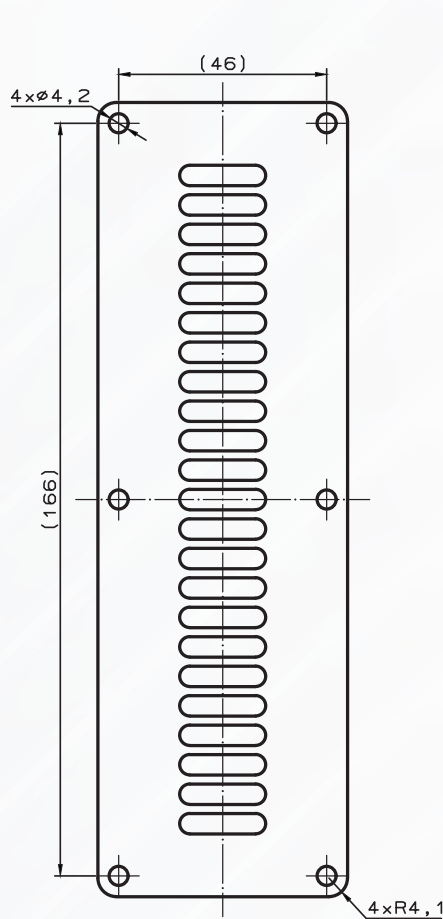

Front view

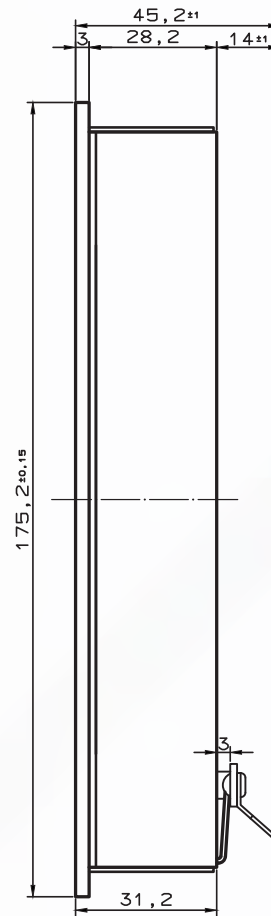

Sideview

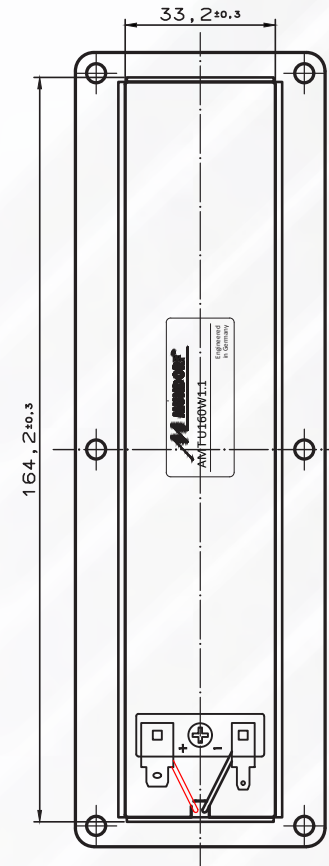

Rear view

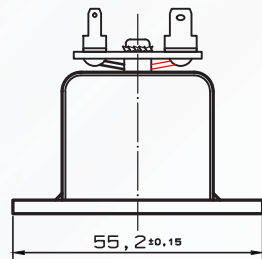

Top view

	Dimensions	Tolerance
Length	175 mm	+ 0,5 mm
Width	55 mm	+ 0,5 mm
Depth including terminal	45 mm	+/- 1 mm

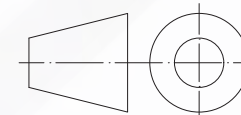

All measurements are in mm.



Air Colis



Resistors



Damping Materials

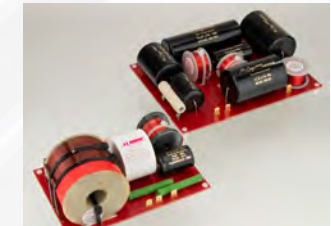

Crossover Network



Audio Capacitors



Car-Audio



Other products by MUNDORF



Mundorf EB GmbH

Liebigstr. 110  
50823 Cologne . Germany

Fon +49 221 977705-0  
Fax +49 221 977705-99

[info@mundorf.com](mailto:info@mundorf.com)  
[www.mundorf.com](http://www.mundorf.com)



Power Capacitors

Note: the technical information present was produced with great care. Nevertheless, since errors cannot be ruled out, we would like to point out that Mundorf EB GmbH does not guarantee the information or take legal responsibility or liability for possible consequences that can be attributed to incorrect information.

All rights reserved.

Subject to technical changes by us at any time.

© Copyright Mundorf EB GmbH 2020